

# SMART

## ALUMINIUM FIXING SYSTEM



### MAIN ADVANTAGES OF SMART SYSTEM

- FASTER INSTALLATION - UP TO 50%
- LIGHTWEIGHT CONSTRUCTION
- EASY FOR MANIPULATION
- PRECISE INSTALLATION
- BLACK COLORED COMPOSITE CLIPS
- EASY TO DISASSEMBLE (IN ENTIRE AREA OF THE DECKING)
- INSTALLATION WITHOUT ANY DRILLING
- 5 YEARS WARRANTY

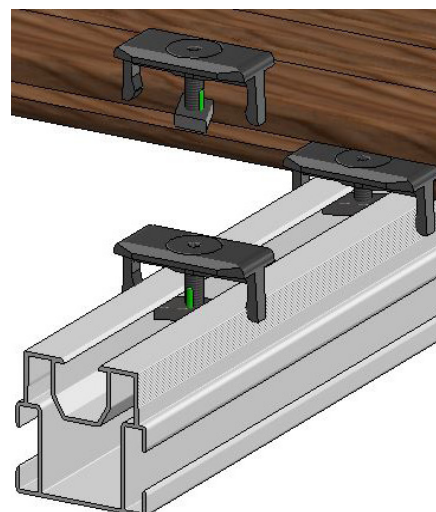

### PRICELIST 2019

ITEM	PRICE
JOIST 23 x 35 x 4000 mm	16.00 €
COUPLING - JOIST 23	1.00 €
JOIST 40 x 43 x 4000 mm	27.00 €
COUPLING - JOIST 40	2.80 €
JOIST 75 x 40 x 4000 mm	48.00 €
COUPLING - JOIST 75	6.00 €
CORNER JOINT - JOIST 40 / 75	4.25 €
STANDARD CLIP - 100 pcs	64.00 €
START CLIP - 1 pc	0.70 €

### INSTALLATION

#### MAXIMAL DISTANCE BETWEEN SUPPORTS OF JOISTS

JOIST 23	max. 30 cm
JOIST 40	max. 50 cm
JOIST 75	max. 100 cm

**WPC - WOODPLASTIC a.s.**

E: [info@woodplastic.eu](mailto:info@woodplastic.eu)  
w: [www.woodplastic.eu](http://www.woodplastic.eu)

# SMART

## ALUMINIUM FIXING SYSTEM

### SMART JOIST 23

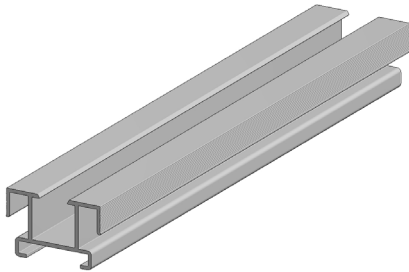

JOIST 23

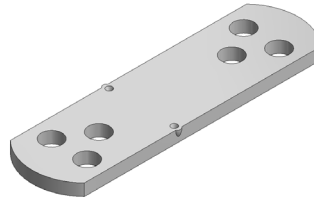

COUPLING - JOIST 23

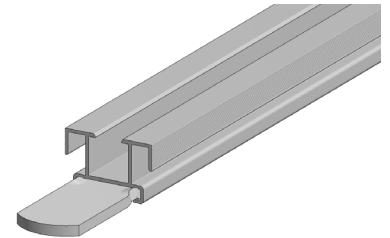

USE OF COUPLING

### SMART JOIST 40

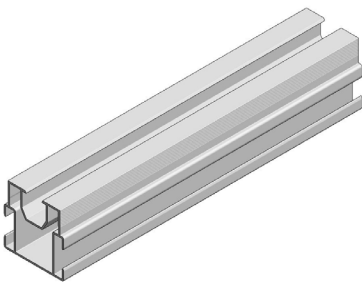

JOIST 40

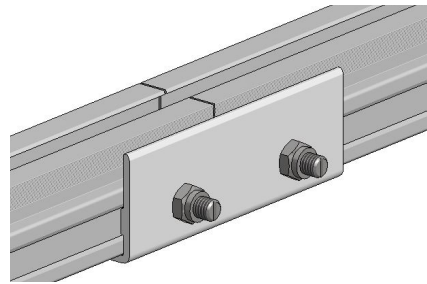

COUPLING - JOIST 40

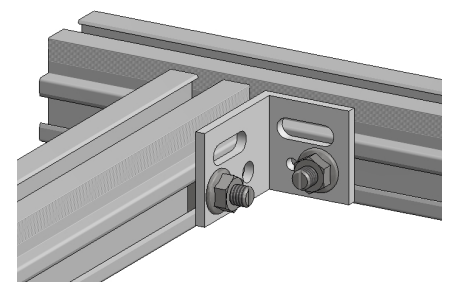

CORNER JOINT

### SMART JOIST 75

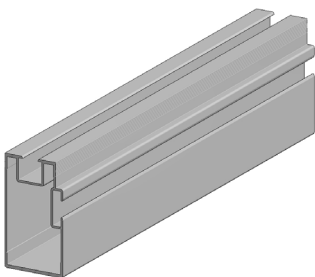

JOIST 75

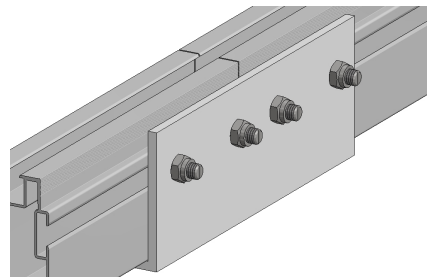

COUPLING - JOIST 75

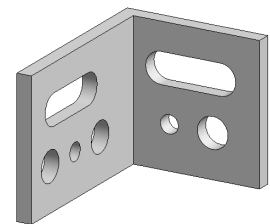

CORNER JOINT

### CLIPS FOR SMART SYSTEM

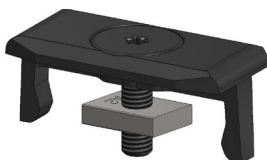

STANDARD CLIP

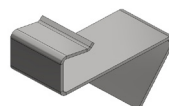

START CLIP